

SESAM: A Semi -Synchronous, Energy Savvy, Application-Aware MAC

Joint work with Renato Lo Cigno and Matteo Nardelli, University of Trento, Italy

Published at IEEE/IFIP WONS 2009, 2-4 February 2009, Snowbird, Utah, USA

Michael Welzl <http://www.welzl.at>

DPS NSG Team <http://dps.uibk.ac.at/nsg>
Institute of Computer Science
University of Innsbruck, Austria

Soon: Networks and Distributed
Systems group, Department of
Informatics, University of Oslo

CAIA guest talk
Swinburne University
Melbourne AUS
12 February, 2008

Outline

- Problem / background
 - History, background
 - Power-conserving MAC schemes for WSN
- SESAM
 - Results
- Ongoing work
- Conclusion

History



- I live in the Pathfinder motel, corner Cotham/Burke
 - Nice place, but WiFi is slooow
 - Last year, I started to wonder if that isn't a bigger problem than high-speed TCP (e.g. I told you about the Window Scaling option issue...)
- **Initial idea:** when it is known that some hosts will send for an extended duration, they can form a clique, to schedule transmissions (a bit like a dynamic temporary token ring) \Rightarrow avoid CSMA/CA collisions
 - I visited Trento to work with Renato Lo Cigno on this
 - ... and found that similar stuff exists - in research, but not in the standard
 - Renato: "this makes more sense for WSNs, where traffic patterns are known"
 - I started to dig into the [energy-conserving-MAC-for-WSN](#) literature
 - Developed a rough idea with Renato, based on explicit dissemination of traffic patterns, to avoid overlaps; quite complex
 - Later, Renato visited me for two days, and told me about his new idea that makes this all much better and simpler, and we discussed it
 \Rightarrow **SESAM !**

Trento context: TRITon project

- Regional project on road (tunnels mainly) management
- Monitoring infrastructure through WSN
- Network availability for rescue and fire dept.
- Energy is a major concern when cabling is not available (most of the times for retrofitting)
- Tmote compliant hardware
- Tiny OS + specialized routing and application software
- Tiny OS implementation of B-MAC ... until SESAM is ready to roll out!!



Web Site: <http://triton.disi.unin.it/>

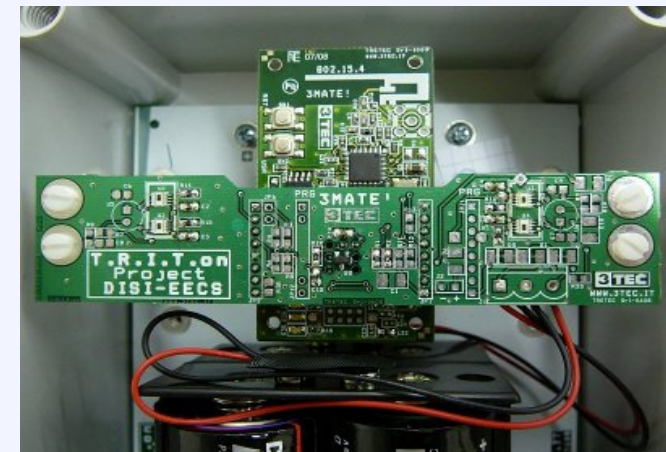

What's an "energy-conserving MAC for WSN"?

- **WSN**: tiny devices, deployed in a way that can make plugging in a power adapter very inconvenient
 - Very, very inconvenient
 - E.g. thrown out of airplane across a cornfield, dumped in the ocean, ...
- Starting point for wireless communication: **IEEE 802.15.4 CSMA (/CA)**
 - Not very energy efficient: e.g. nodes are *always* awake to listen
 - Hence, WSN hardware commonly implements only PHY + low level framing parts of IEEE 802.15.4 spec; MAC typically customized
 - CSMA(/CA) behavior typically used as fallback in WSN MAC schemes
- Energy-conserving MAC work usually starts with the question: "What if we sometimes put nodes to sleep on top of CSMA?"
 - Note: **idle listening** is usually the most energy consuming part

Energy-conserving MAC examples

- **S-MAC**: Everyone sleeps most of the time. Occasionally, senders and receivers wake up together to contend for the channel
 - With several suggested improvements: e.g. immediately go back to sleep after hearing an RTS or CTS packet that is not for me
 - **T-MAC**: terminate time slots early when nodes don't have anything to send
- **TDMA schemes / hybrids**
 - **TRAMA**: alternate between...
 - random access phase: nodes tell each other transmission schedules
 - Scheduled phase: use the schedules to avoid contention
 - **FLAMA**: does not need schedule announcements, exploits knowledge of application-specific traffic patterns ("flows")
 - **Z-MAC**: schedules assumed to be more static - assigned in the beginning and upon major network configuration changes
 - **Funneling-MAC**: improves upon Z-MAC by exploiting typical tree-upstream data flow for schedule distribution

Energy-conserving MAC examples /2

- Low Power Listening (LPL): sender transmits preamble before actual data, potential receivers regularly probe the channel
 - B-MAC: preamble length > receiver sleep period \Rightarrow receiver will not miss it
 - Problem: power wastage for sending long preamble
 \Rightarrow several mechanisms improve this: [WiseMAC](#), [X-MAC](#), [SCP/MAC](#), ...

A simple model of B-MAC

Low level MAC	802.15.4
Idle power	1 μ W
Sense power	30 mW
Rx power	60 mW
Tx power	25 to 50 mW

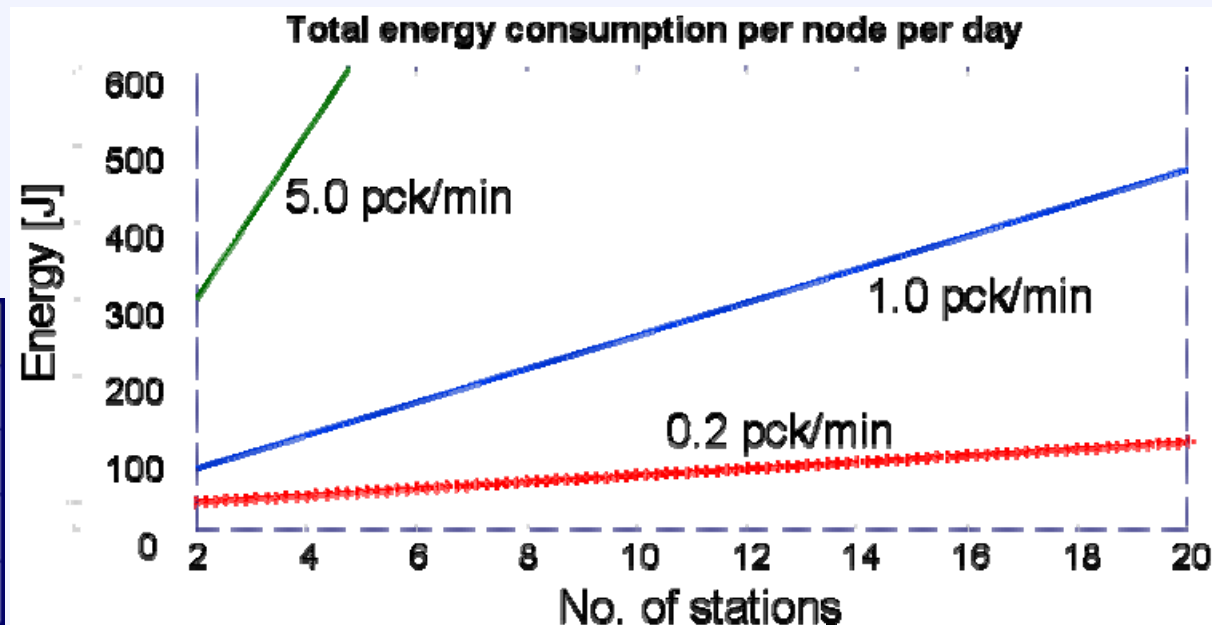

B-MAC energy consumption: detail per function

Thus, goal:
avoid that.

Energy consumption per day per node
for each function; 1 pck/min

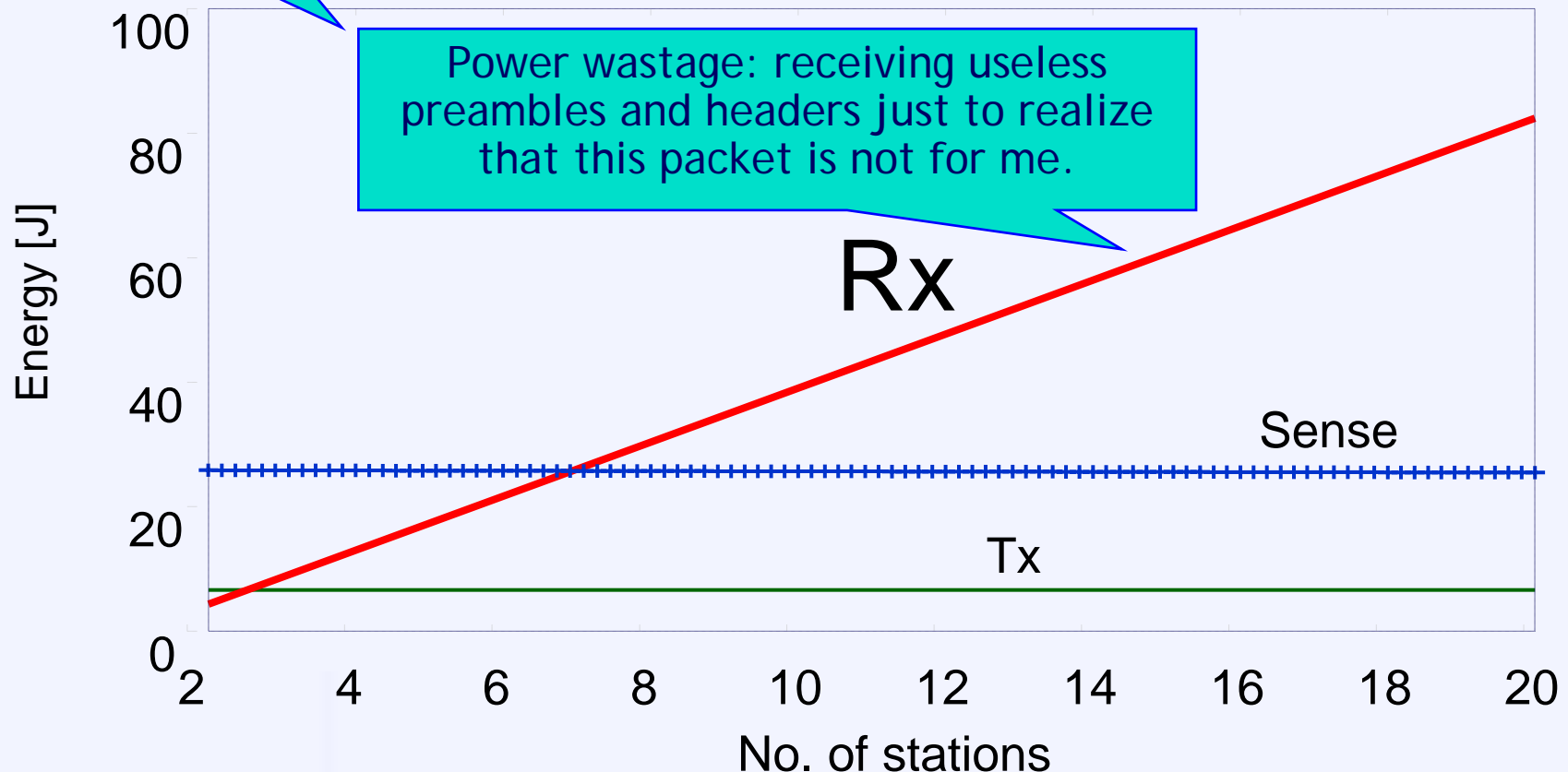

SESAM

- Idea: exploit special properties of WSNs
 - WSNs are not general purpose; they fulfill special tasks
 - Very low traffic on average
 - Mediated by a routing middle-layer
 - Stable and predictable traffic relations toward sinks
 - distributed data fusion is interesting, but rarely used and supported
 - Alarms must be supported, but response time of seconds is O.K.
- Design goals
 - Reduce needless sensing, minimize overhearing
 - Decouple sensing traffic from alarms and management
 - Minimize global coordination (no TDMA) and signaling
 - Use standard & available low level routines
 - Consider simple, pairwise (i,j) coordination
 - App. often knows next transmission time \Rightarrow let's use this for coordination

SESAM: global timing

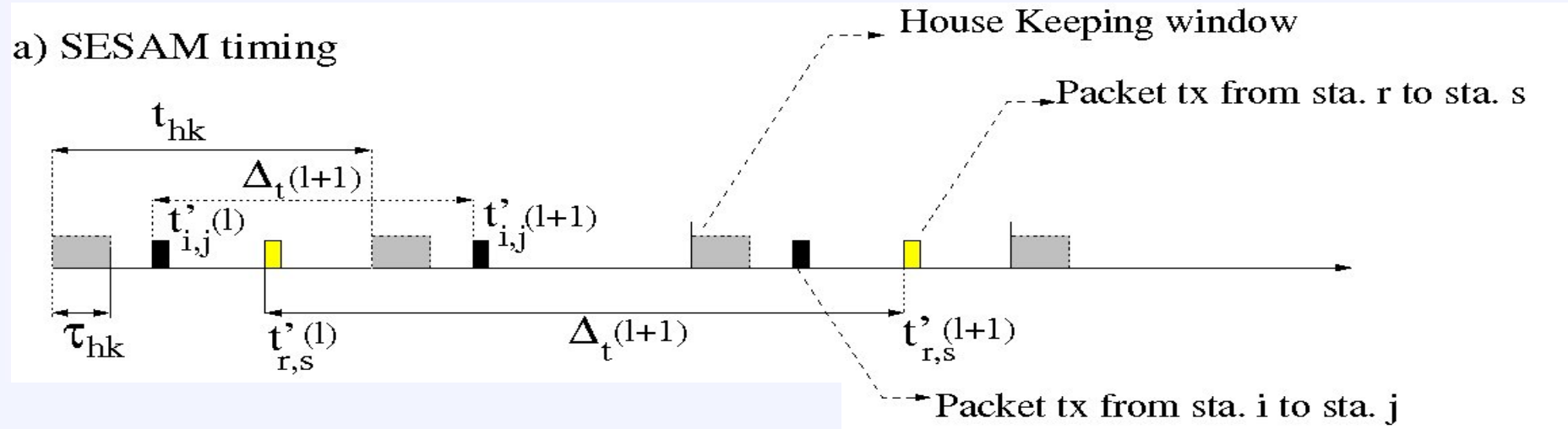

- With every packet, Tx station tells Rx station the next transmission time
 - Rx will then wake up again \Rightarrow (almost) no useless waking up and listening at all!
 - Traffic relations of Tx/Rx pairs are decoupled except for occasional contention
- Additionally, everyone wakes up in housekeeping periods
 - used for establishing new relations, broadcast, routing, management, bootstrap

SESAM: local timing and collision resolution

- Preambles compensate for clock drifts

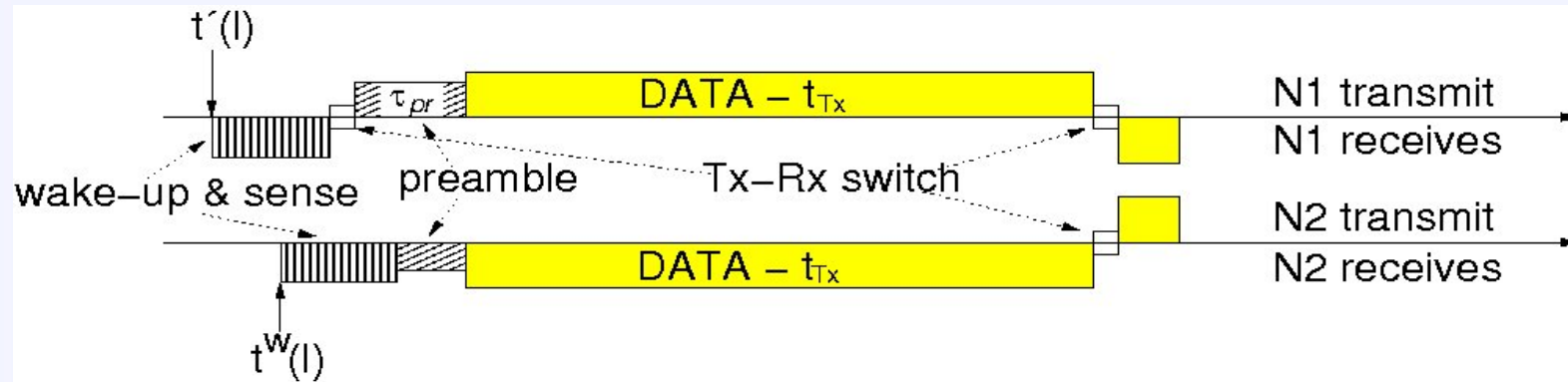

- Collision:
 - Behave like a 0-persistent CSMA, i.e. wait for a while and try again
 - Normally bad: goal = de-correlate access in time with overloaded channel
 - Here: channel not overloaded, goal = de-correlate different traffic relations
 - If "for a while" is a constant, traffic relations A-B and C-D will collide again
 - ⇒ use pseudo-random sequence, known to Tx and Rx host in a traffic relation
 - Repeat in case of another collision
 - Upon success: maintain new timing!

SESAM: collision resolution /2

- In case of repeated collisions: how long can we shift the time ahead?
 - Limit: next (normally) scheduled sending time
 - If time shift exceeds it, retransmit packet at next scheduled time instead
 - But let it carry new displacement (MOD "normal" schedule duration)
 - upon failure: abort traffic relation, discard packet, establish again
- What if an ACK is lost?
 - Sender and receiver are desynchronized
 - Sender moves ahead in pseudo-random sequence, receiver does not
 - Solved by retransmission of packet in next "normal" time slot
 - This is when the receiver expects a packet and wakes up
 - The packet will carry the next displacement, so sender and receiver become synchronized again

Results

- Comparison with two models of B-MAC
 - BenchMAC-0: CDMA + LPL 0-persistent on contention
 - BenchMAC-1: CDMA + LPL 1-persistent on contention
- Custom made simulations based on PeerSim with the actual consumptions measured on our nodes per each function
- Single collision and housekeeping domain
- Realistic default protocol parameters - packet sizes, durations, transmission power... all given in the paper, not shown here to keep you from falling asleep

Results: Total energy consumption

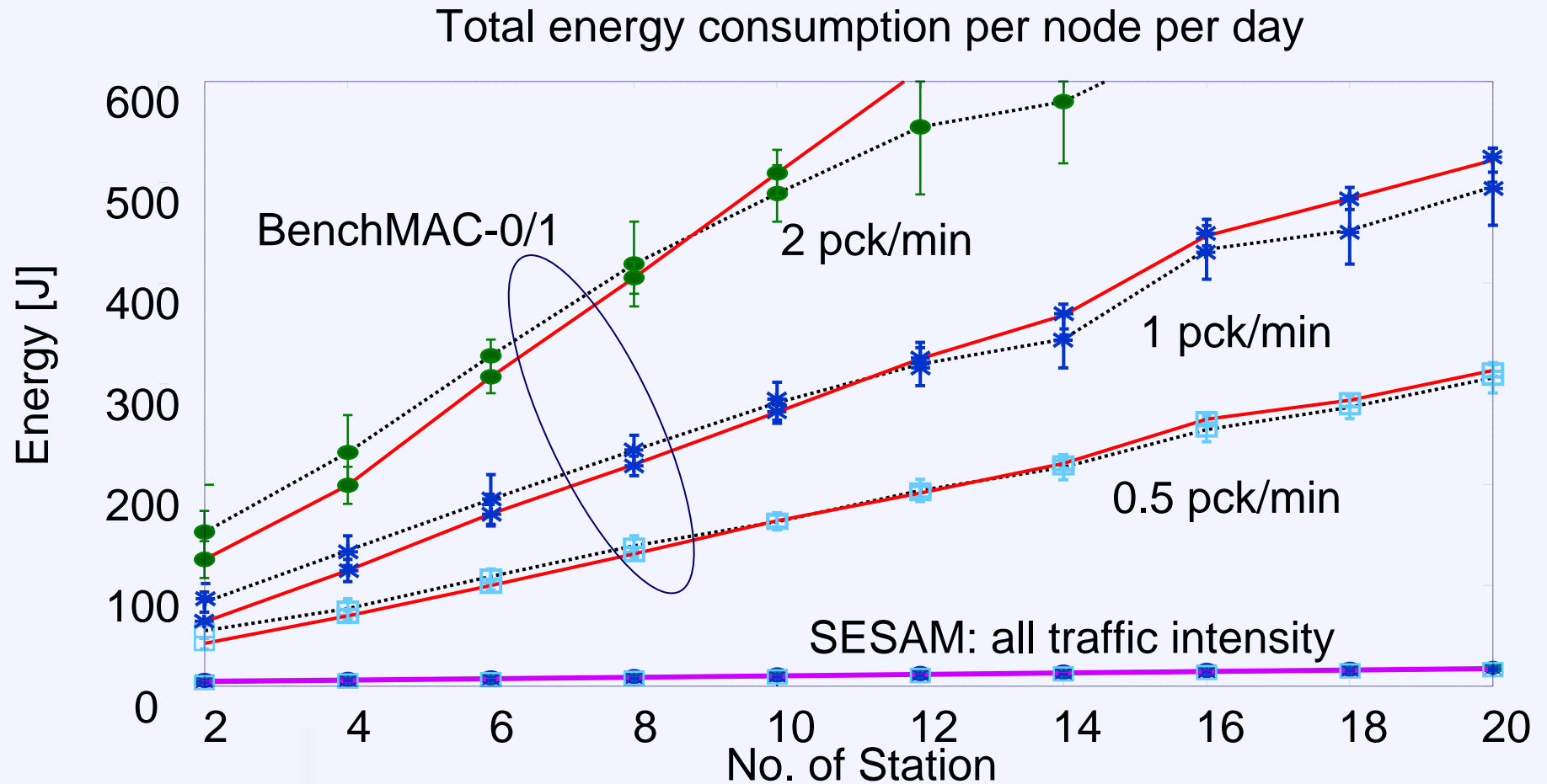

Results: losses for traffic bursts

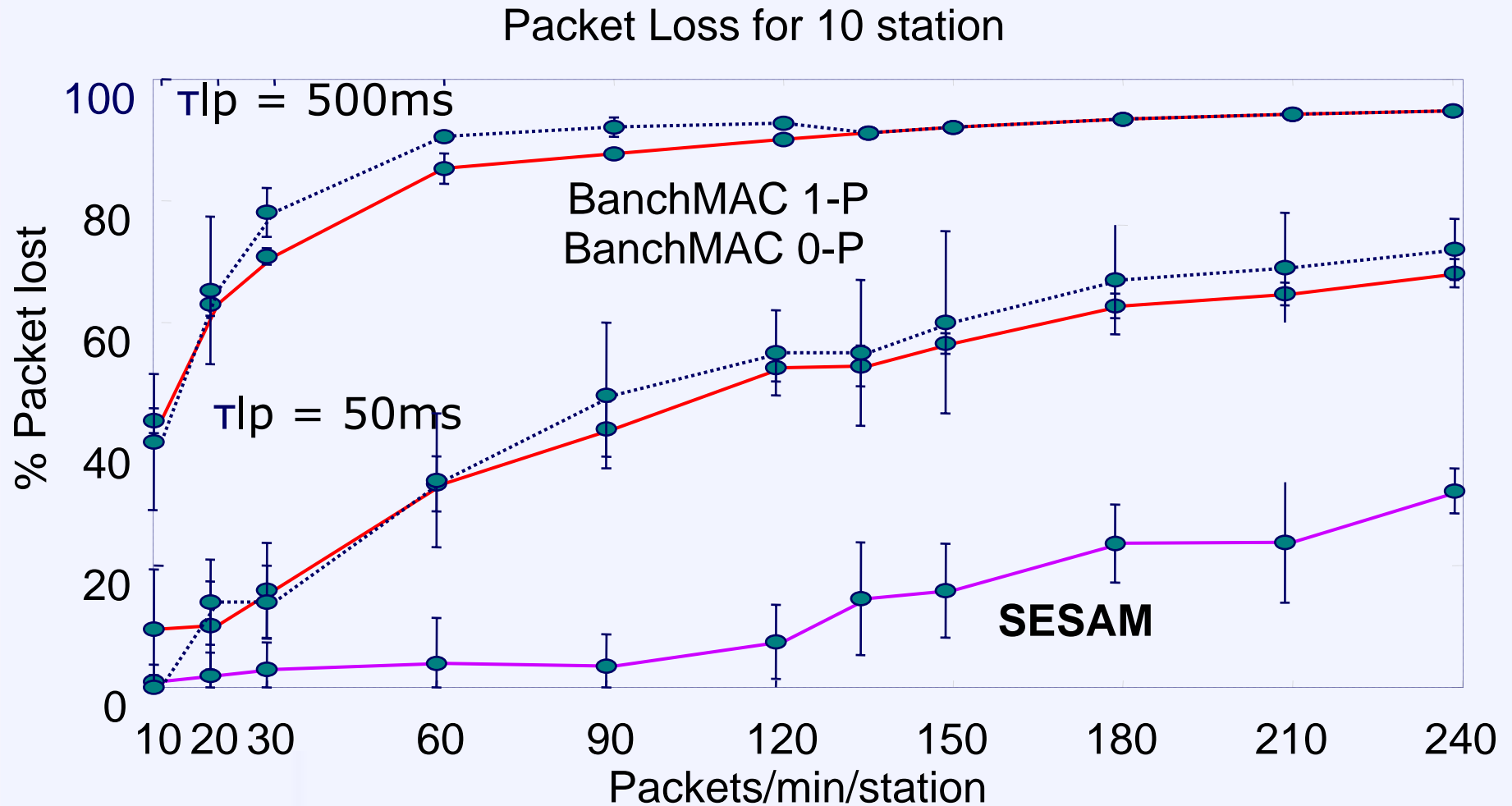

Ongoing work @ Trento

- Multi-housekeeping management for support of multiple collision and housekeeping domains

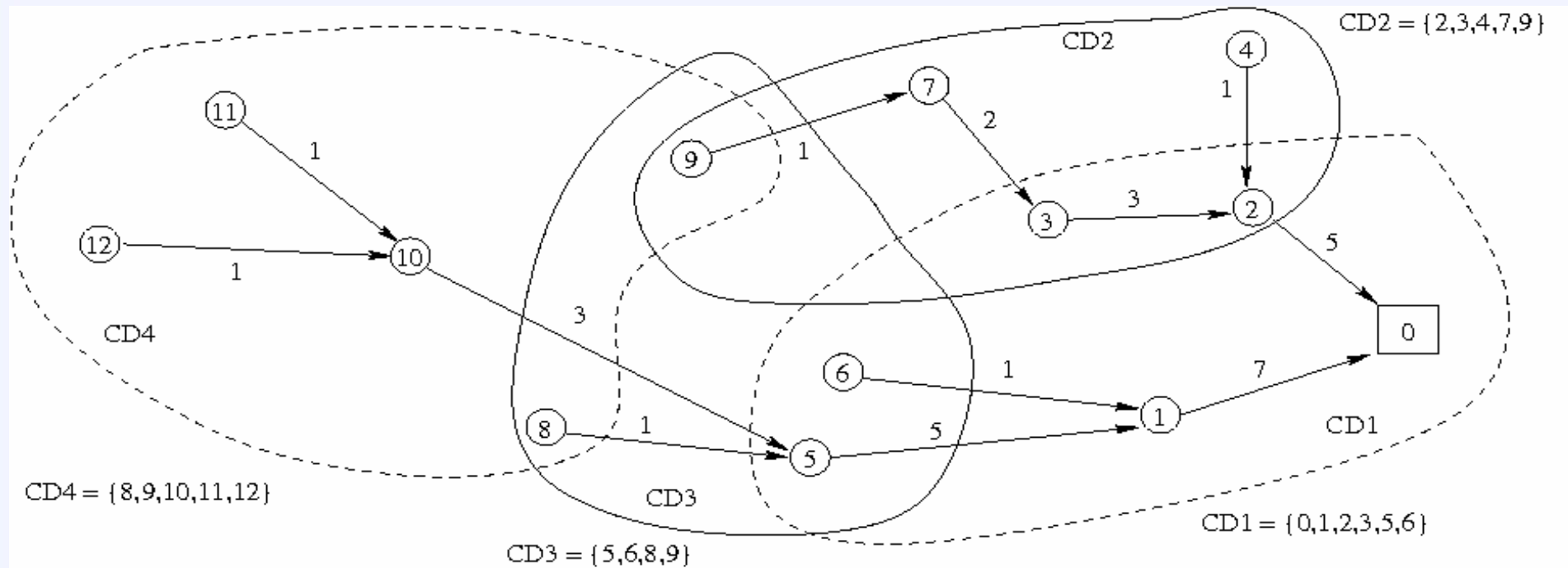

- Implementation in TinyOS is planned in the next months

Conclusion

- WSNs are specialized, not general purpose networks
- Energy consumption is critical, often the enabling factor: communication functions (not transmission) dominates
- SESAM can reduce energy consumption by 1-2 orders of magnitude
 - Makes energy a non-problem
 - Years of lifetime out of AA batteries (like your gate remote controller)
- Further investigation + implementation work is underway

Thank you!

Questions?